



verbraucherzentrale

Nordrhein-Westfalen

SAVING ENERGY AT HOME

Cheap, good and healthy housing

Consumer Association of North-Rhine Westphalia (Verbraucherzentrale NRW)

The Verbraucherzentrale NRW helps people in many subjects, for example in the case of problems with mobile phone contracts, loans, bills or energy suppliers.

The Verbraucherzentrale NRW has general advice centres in 61 cities in North-Rhine-Westphalia. We can help you there. The Verbraucherzentrale NRW is independent.

More than 90 percent of the people in North-Rhine-Westphalia trust the Verbraucherzentrale NRW, because they help many people.

You can find information and the addresses of the general advice centres on the internet at: www.verbraucherzentrale.nrw

We advise you how you can save energy and money.

For people who do not have much money, advice is free of charge:

☎ 0211 - 33 996 555

energieberatung@verbraucherzentrale.nrw

Energy costs a lot of money!

Heating, hot water and electricity are very expensive in Germany.

If you need less energy, you will save a lot of money and protect the climate. This brochure informs you how to do so.

These pictures show how much heating, hot water and electricity cost on average a year for 3 people living in an apartment (65 m²).

Electricity

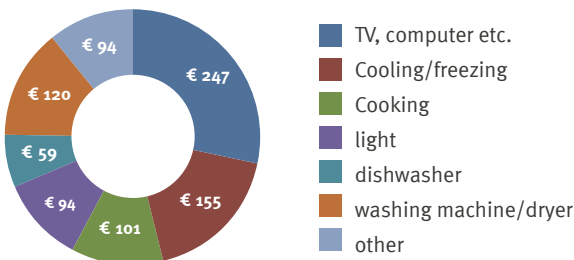
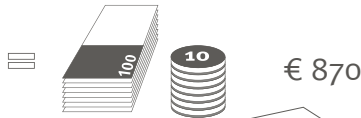

Heating

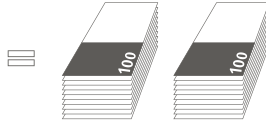

€ 2000 (with electricity, see page 3)

€ 715 (with oil or gas)

Hot water

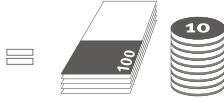

€ 580 (with electricity, see page 9)

€ 120 (with oil or gas)



When should you heat?

Most people in Germany feel comfortable when the temperature in the apartment is between 18 and 22 degrees Celsius. We need to heat when it is cold outside. We normally heat between October and April.

Outside temperature (day/night average)

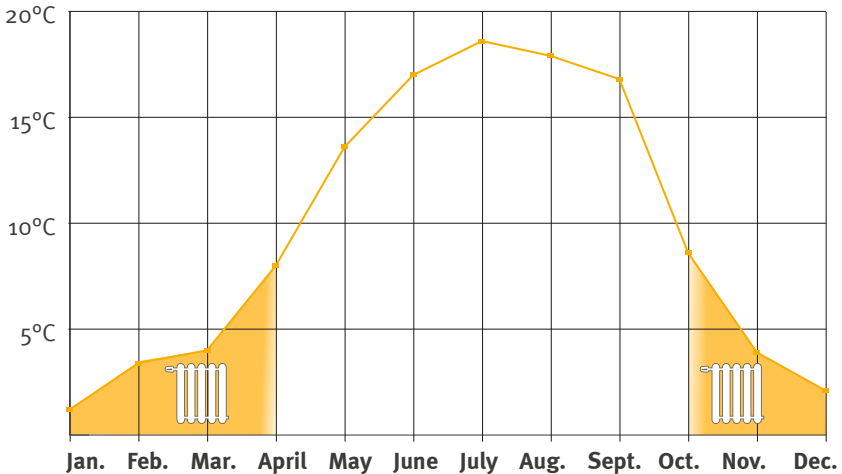



How to heat properly

Each apartment has heating. There is usually a control knob on the heater (thermostat). Turn the knob to get the right temperature. You use only the heater for heating.

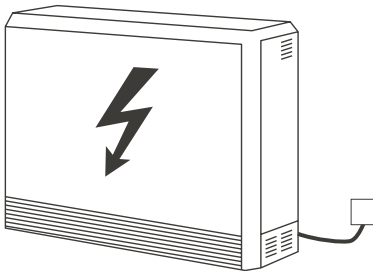
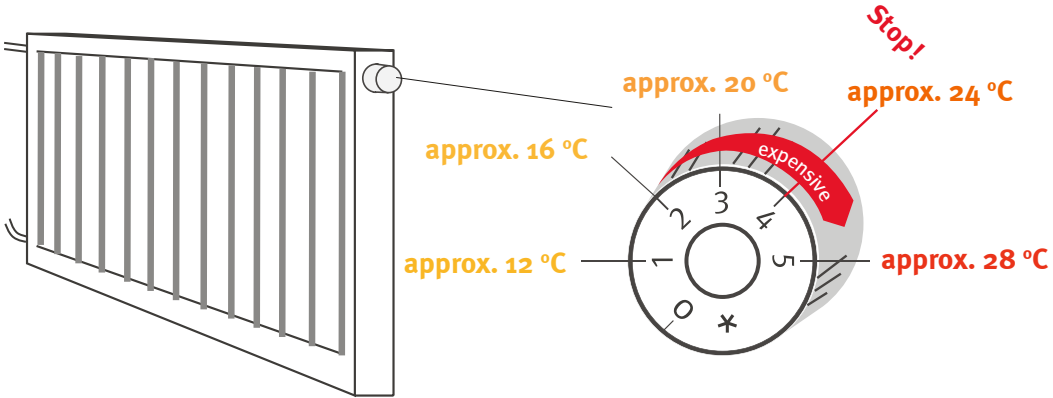

Heating is expensive. Heaters that need electricity are particularly expensive. These heaters have a power cable. Get advice if you have this kind of heating.



Economical heating

You save money when the heater is set correctly.
The warmer the heater, the more expensive the heating bill.
Caution: If the apartment is too cold, it will get mouldy.

We recommend:



Bedrooms: level 2-3, 16-18°C



Kitchen: level 2-3, 18°C



Bathroom (when you are in the room): level: 3-4, 21-24°C



Living room, children's bedrooms, working rooms: level 3-4, 20-21°C

Turn the heater down to level 2 when no one is at home. This way you will save money. Do not set the heating to level 0 in winter!

- Do not place furniture close to the heating. Curtains should not hang in front of the heating.

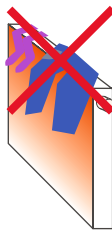

- Do not place any clothes on the heater.

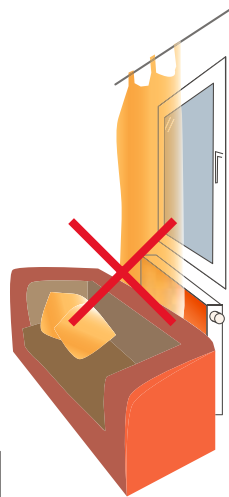

- Switch the heating off when you open the window.

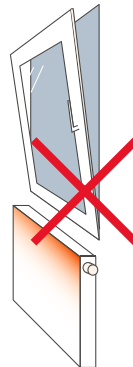



Ventilate properly

Through showering, cooking, drying laundry and living water gets into the air. This water must be removed from the apartment. Water will cause mould to grow. You must ventilate. This is very important in winter!

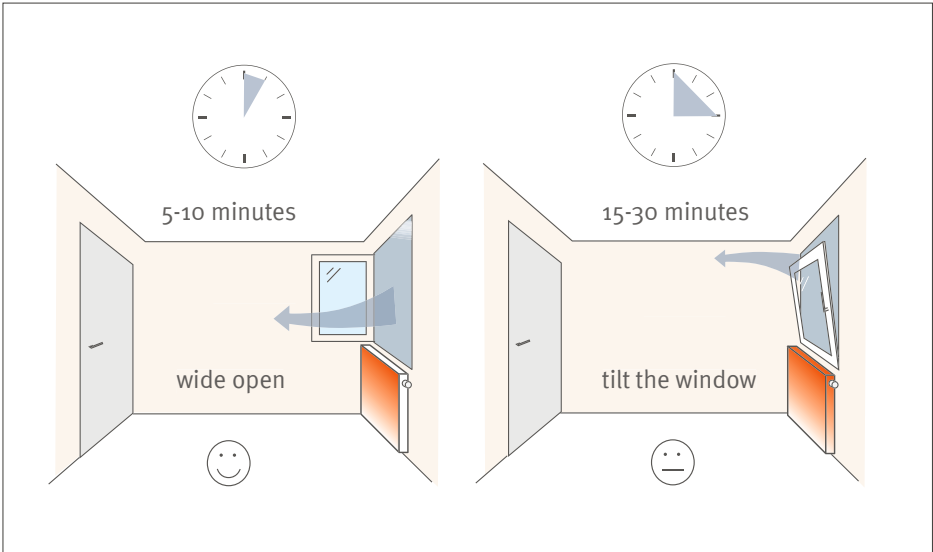
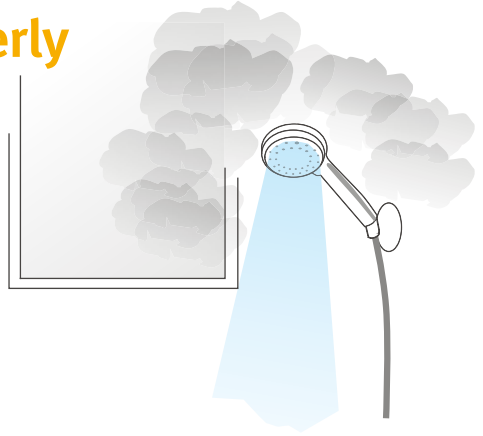

- Open the window wide at least three times a day. The window should remain open for 5-10 minutes.
- If you tilt the window, you must ventilate for 15-30 minutes.

- Ventilate immediately after cooking, bathing or showering.

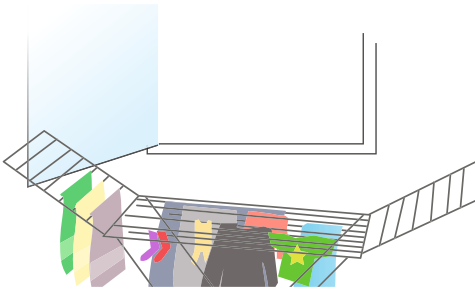
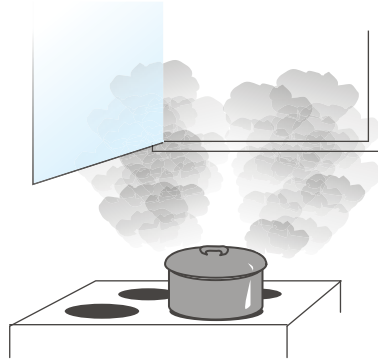

- If you dry laundry in the apartment, you need to ventilate a lot. If you do not ventilate a lot, mould will grow!
Caution: in many apartments, the drying of laundry is prohibited.

What is mould?

Water causes mould in the apartment and makes nasty stains. Mould can make you ill. Mould is often found in corners or behind furniture. If you see a lot of mould, contact your landlord.

Tip: Come to an advice centre. We will advise you!





Washing and drying

You can save money while you are washing and drying:

- Make sure that the washing machine is full. Then you save electricity and money.

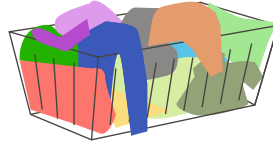

- The hotter the temperature, the more expensive it is. Normal laundry needs 30 degrees Celsius.
- If you are drying laundry in the dryer, you must spin the laundry first. Choose 1,400 revolutions.

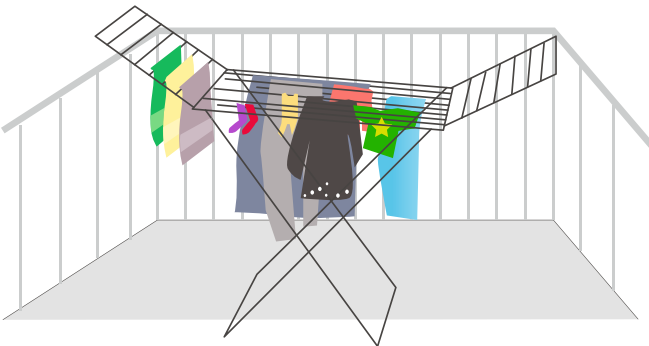
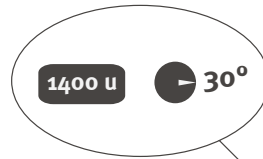

- Dry your laundry in the basement, in the attic, on the balcony or in the garden.



Cooling and freezing

If the refrigerator or freezer is too cold, you will pay a lot of money:

- The refrigerator should be set to 7 degrees Celsius (level 2 or 3).
- The freezer should be set to minus 18 degrees Celsius.
- You can check the temperature with a thermometer.

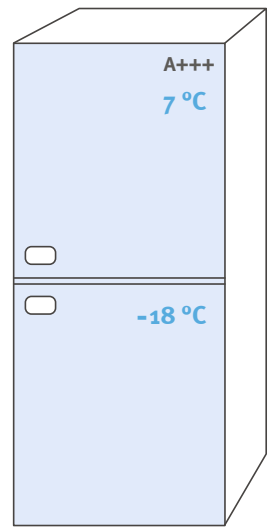
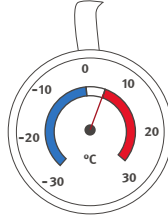

Cooking and baking

Save money while you are cooking and baking:

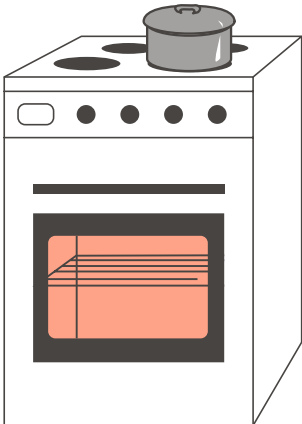

- Put a lid on pots and pans.
- Reduce temperature after water for vegetables, pasta, potatoes or rice has boiled.
- Use thermal carafes for tea or coffee.
- Use a kettle to boil water. You will boil water faster and you will pay less for electricity.
- You must not use the oven for heating.





Hot water

Cold water is cheap - hot water is expensive.

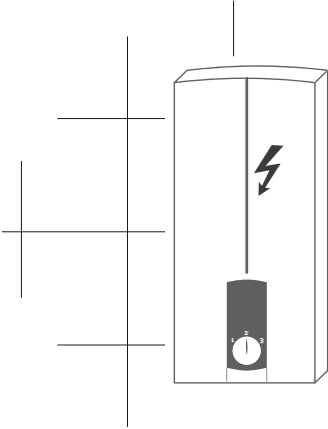

Caution: In many homes, hot water comes from the boiler. The boiler looks like this and works with electricity. Electricity is very expensive! Go and get advice in a general advice centre.



Washing dishes

- Wash the dishes in the sink. Hot water is expensive. You don't need much water in the sink. You will save money!

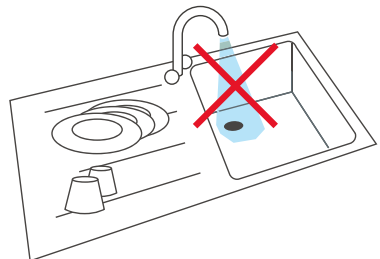
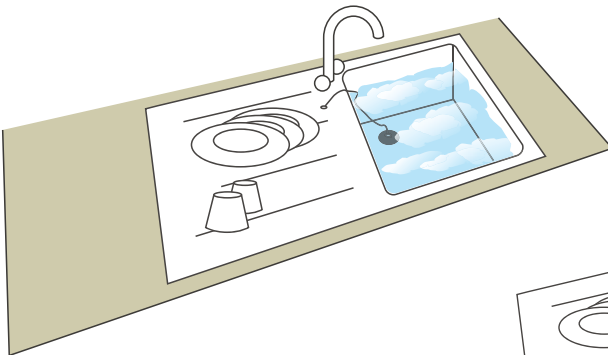



Shower

- Shower for 5 minutes only.
- Short showers are cheap, having a bath is expensive.

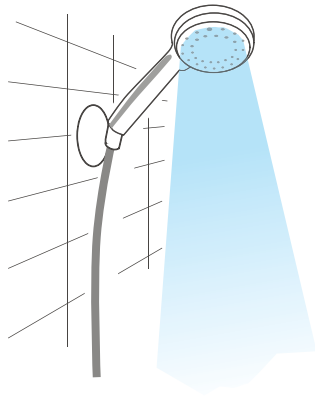

5 minutes

- Water should not run while you are shaving or brushing your teeth.



Light, computer and TV

Light needs electricity. Electricity is very expensive.

- Switch off the light when you leave the room.
- Buy economical LED lamps.
- Switch off devices completely. If a light shines, the device still needs electricity ("stand-by"). Pull out the plug or buy a plug strip with a switch.

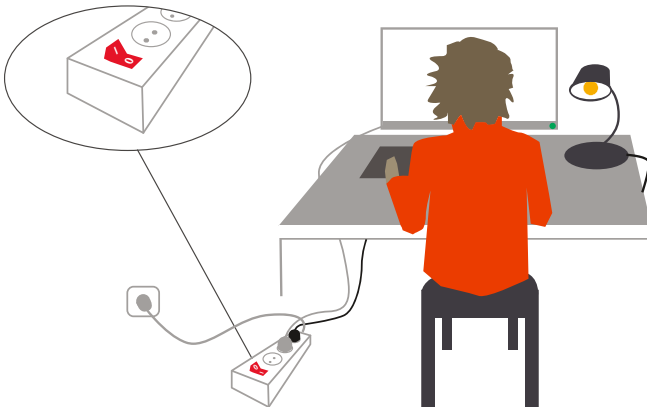

Buy economical devices

Pay attention to energy consumption, if you buy a new electrical device. This colourful drawing will help you: Dark green is extremely economical.

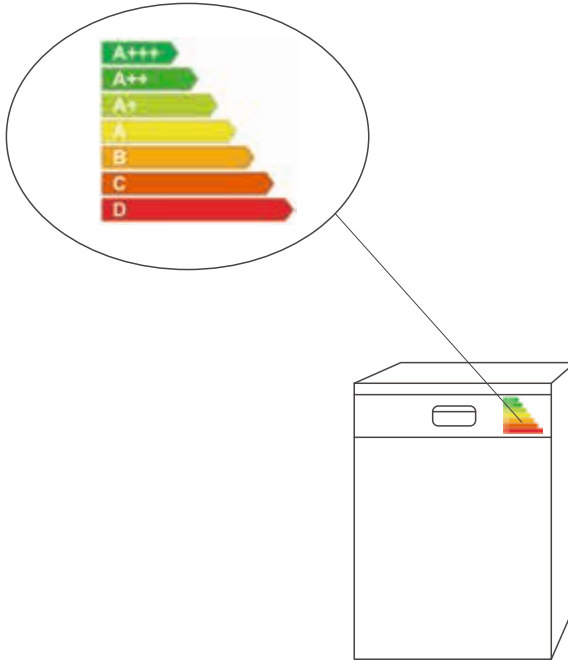

This brochure is intended for people with a low level of the English language.

Further information at: www.verbraucherzentrale.nrw/fluechtlingshilfe

Information and dates for energy advice:

 www.verbraucherzentrale.nrw/energieberatung

 0211 - 33 996 555

 /vznrw.energie  /vznrw_energie

LEGAL NOTICE

Published by
Verbraucherzentrale Nordrhein-Westfalen e.V.
Mintropstr. 27
40215 Düsseldorf



Gedruckt auf
100%
Recyclingpapier

ed/2017_Bilder ©fotolia.com: svwart, Zlatan Durakovic
Grafik: B&B Werbeagentur für NRW, Lea Reck
Druck: UH-Media GmbH_10.000

Gefördert durch



EUROPÄISCHE UNION
Investition in unsere Zukunft
Europäischer Fonds
für regionale Entwicklung

Ministerium für Umwelt, Landwirtschaft,
Natur- und Verbraucherschutz
des Landes Nordrhein-Westfalen



EFRE.NRW
Investitionen in Wachstum
und Beschäftigung